



Installation Instructions **POWER TRACE ETC1 CONTROL**



PowerTrace etc1

CONTENTS		page
SECTION 1. OVERVIEW		
1.1 Precautions.....	2	
1.2 Base model components.....	2	
1.3 Operation.....	2	
1.4 Default Settings	2	
SECTION 2. INSTALLING		
2.1 Installing the PowerTrace control panel	3	
2.2 Installing the 100-Ohm platinum RTD	4	
2.3 Electrical connections	5	
2.4 Wiring contacts for remote alarm	6	
SECTION 3. PROGRAMMING		
3.1 LED display settings	7	
3.2 Programming setpoint temps and alarms	8	
3.3 Ground fault alarm	11	
3.4 LED screen alarm displays and resetting alarms.....	11	
3.4 Locking the keypad.....	11	
SECTION 4. TESTING AND TROUBLE SHOOTING		
3.1 Maintenance	12	
3.2 System function test	12	
3.3 Trouble shooting and Technical Support	12	

Section 1. Overview

1.1 PRECAUTIONS

- Installation must comply with local electrical codes.
- All related components and this control should be properly rated for the specified location classification.
- The control must be installed by a qualified electrician.
- The PowerTrace enclosure is rated NEMA 4X and must be located appropriately.

1.2 BASE MODEL COMPONENTS

PowerTrace etc1 is available in the following models:

ETC-120	120 VAC (UL Listed)
ETC- 208/240	208 or 240 VAC (UL Listed)
ETC-277	277 VAC (UL Pending as of this printing)

Each unit includes a control panel with keypad and digital display, 100 ohm platinum RTD with a temperature coefficient of 0.00385, and 30 mA ground fault protection of equipment.

The ETC-120 and ETC-208/240 models are UL Listed as temperature indicating and regulating equipment. The UL Listing is for hazardous locations C1D2 Groups A, B, C, & D. The ETC-277 model is UL pending as of this printing.

1.3 OPERATION

The PowerTrace etc1 is intended to control heat trace cable in the application of pipe tracing or tank tracing.

The heat trace cable will activate when the pipe line temperature falls below setpoint temperature. The heat trace cable remains activated until line temperature exceeds setpoint temperature.

IMPORTANT: The PowerTrace etc1 controls are intended to control heat tracing cable under normal operating conditions. Where malfunction or failure of the controller could lead to an abnormal operating condition that could cause personal injury or damage to equipment or other property, other devices or systems intended to warn of or protect against failure or malfunction of the controls must be incorporated into the control system. Such devices include limit or safety controls and alarm or supervisory systems.

1.4 DEFAULT TEMPERATURE, MONITORING, AND ALARM SETTINGS

- Setpoint Temperature = 40°F
- Low Temp Alarm = 35°F
- High Temp Alarm = 250°F
- Low Current Alarm = 1 amp
- Built-in 30 mA G.F.P.E. latching alarm

Accuracy of temperature ranges:

32°F to 200°F +/- 4°F

201°F to 500°F +/- 3%

501°F to 800°F +/- 5%

Section 2. Installation

2.1 INSTALLING THE POWERTRACE ETC1 CONTROL PANEL

The PowerTrace etc1 control panel can be installed outdoors or indoors. Locate per building plans or other suitable location as directed. Mount the PowerTrace control panel to unistrut type brackets using the external mounting holes on the enclosure to allow air circulation around all surfaces for cooling.

Note: Mounting hardware not included.

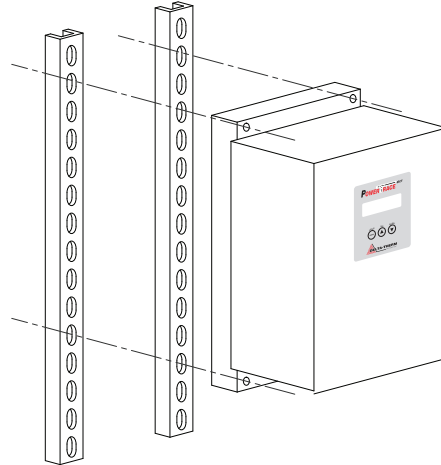

Detail 1. Typical installation side angle.

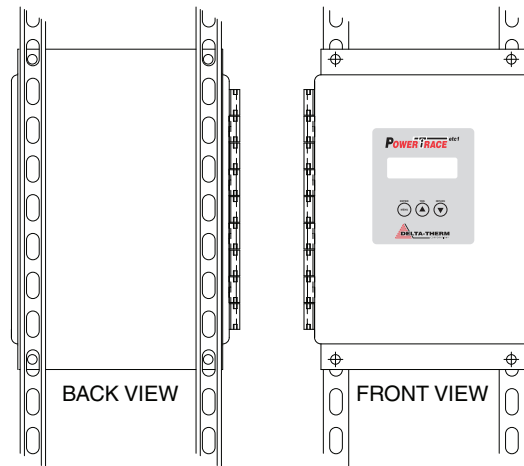

Detail 2. Typical installation front angle.

Section 2. Installation

2.2 INSTALLING 100-OHM PLATINUM RTD

1. Attach the RTD sensor to the pipe using fiberglass tape or pipe straps.
2. Mount on the pipe at the furthest point from the heat trace cable and near heat sinks in the piping system, i.e. pipe supports, valves, or other equipment drawing heat from the pipe.

NOTE:

- a. This is to avoid freeze-up under flow/low flow conditions in these locations.
- b. Do not install RTD wiring in conduit containing line voltage.

3. Route RTD sensor wire either directly to the PowerTrace control panel or to a junction box and then to the PowerTrace control panel via conduit.
4. Connect RTD to terminals on the circuit board.

NOTE: Do not use the RTD for ambient temperature sensing. If sensor temperature falls below 0°F the low temp alarm will activate.

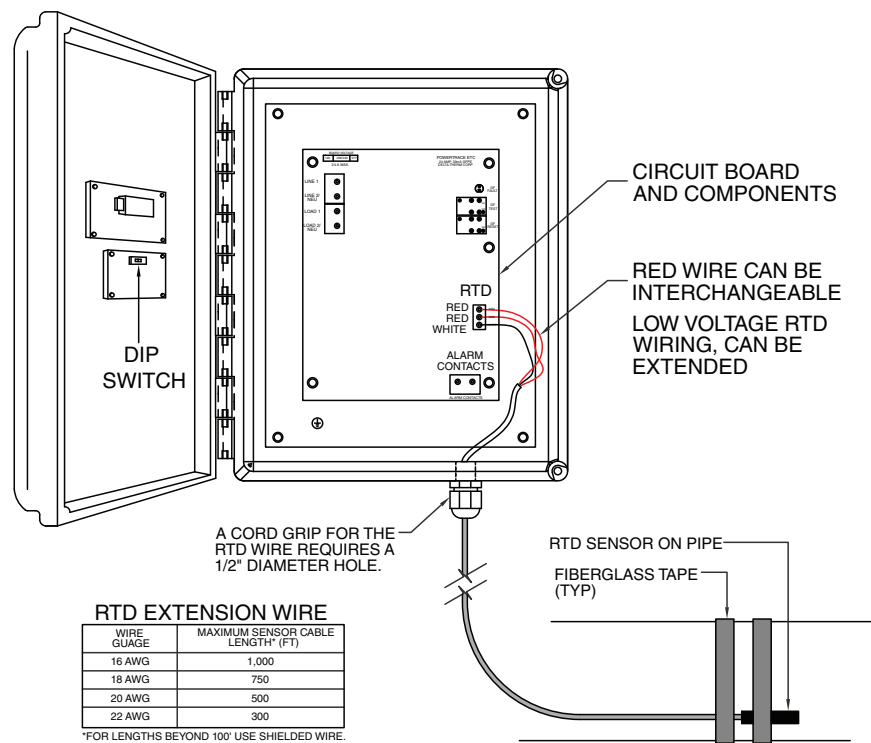

Detail 3. Attach RTD sensor to pipe and route the RTD sensor wire to the terminal block inside of the PowerTrace control panel.

Section 2. Installation

2.3 ELECTRICAL CONNECTIONS

1. Install conduit as required using appropriately rated fittings for the PowerTrace FRP fiberglass enclosure.
2. Verify the operating voltage of the control panel and heat trace cable to ensure the correct voltage will be applied.
3. Select the proper wire gauge per load and building code.
4. The control panel is rated to 24 amps on a 30 amp circuit breaker. Connect the line voltage wiring to the line 1 and line 2/N terminals on the circuit board.
5. Ground the device per code.
6. Connect the load wire to load 1 and load 2/N.

NOTE: The load wiring is ground fault protected and must be isolated from all other wiring. Alarm contacts are rated for 0.5 amps and 24-120 VAC.

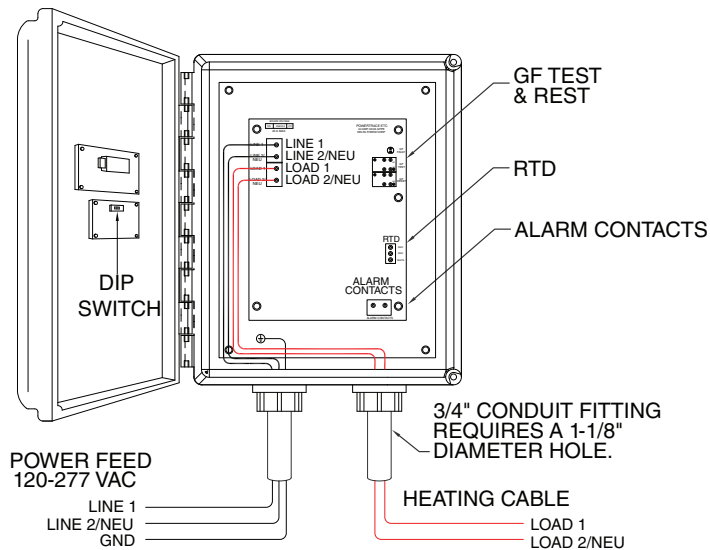

Detail 4. Wiring heat trace cable and power feed directly to the PowerTrace control panel.

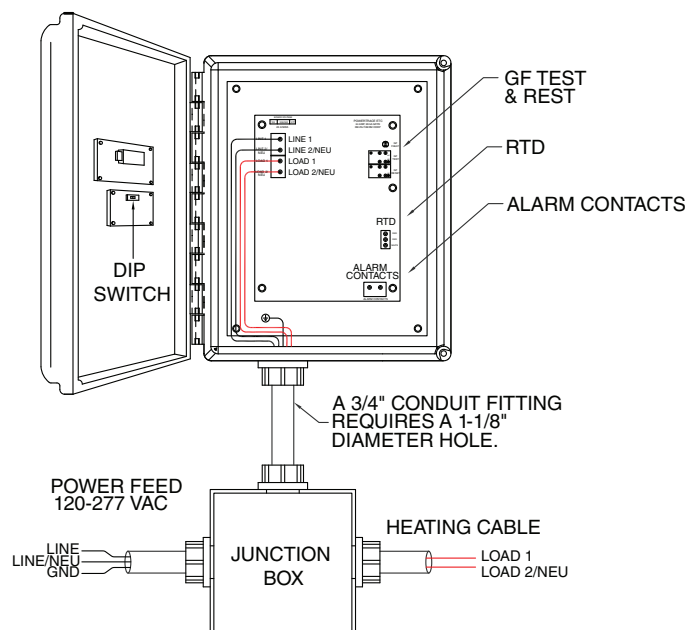

Detail 5. Wire heat trace cable and power feed to junction box, then to PowerTrace control panel.

Section 2. Installation

2.4 WIRING CONTACTS FOR REMOTE ALARM

NOTE: A ground fault alarm will keep the alarm contacts closed continuously. All other alarms will cycle the contacts open and closed.

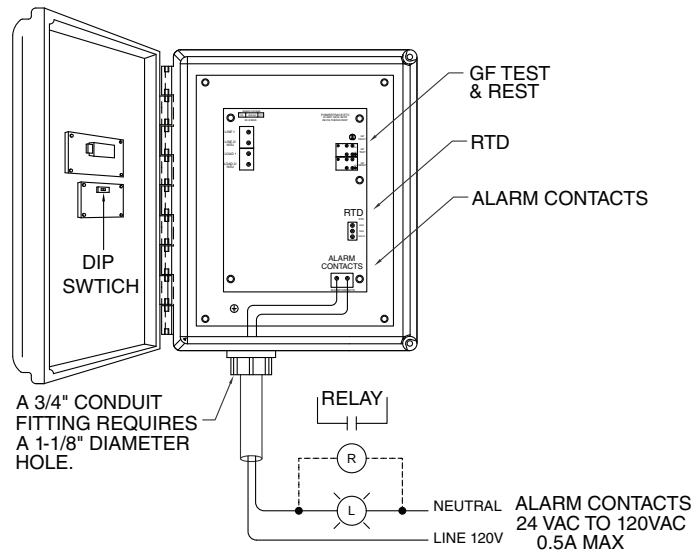

Detail 6. Wire alarm contacts.

Section 3. Programming

3.1 LED DISPLAY SETTINGS

The banner heading “Delta-Therm Corp Heat Trace CTL” is displayed after applying power to the control panel. After the banner heading is displayed the LED screen will display the temperature as detected by the RTD and the control panel setpoint temperature.

If the keypad is locked-out, move the dipswitch on the inside enclosure door into the enable position.

FACTORY DEFAULT SETTINGS:

Setpoint Temperature = 40°F

Low Temp Alarm = 35°F

High Temp Alarm = 250°F

Low Current Alarm = 1 amp

Temperature cannot be set lower than 0°F.

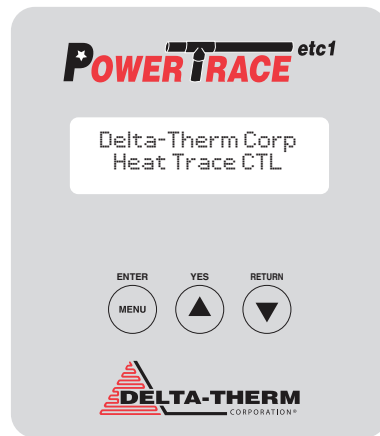

Detail 8. Display message upon first applying power to the control panel. This will display for a few seconds only.

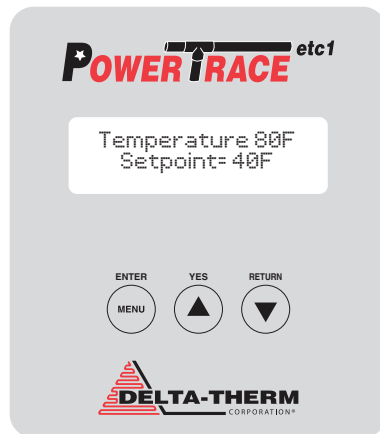

Detail 9. Default display message, temperature as detected by the RTD and control panel setpoint.

Section 3. Programming

3.2 PROGRAMMING SETPOINT TEMPERATURE, LOW TEMPERATURE ALARM, HIGH TEMPERATURE ALARM, AND LOW CURRENT ALARM

There are three dual purpose selector push-buttons: “ENTER/MENU”, “YES/arrow pointed up” (referred to as “YES/up”), and “RETURN/arrow pointed down” buttons (referred to as “RETURN/down”). The parameters can be accessed in the following order:

1. **To access parameters:** Press the “ENTER/MENU” button for up to 4 seconds and the LED screen will display: “Set Parameters? Yes or Return”. Press “YES/up” to enter or change parameters. Press “RETURN/down” to return to the main display.

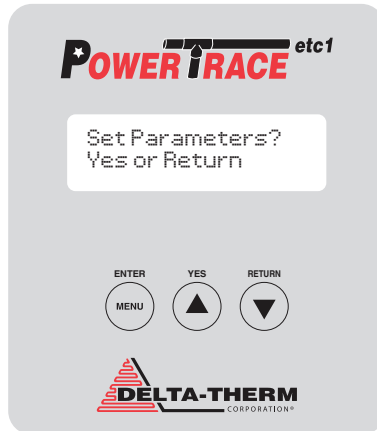

Detail 9. To set parameters press the “YES/up” arrow button.

2. **To enter or change the setpoint temperature:** Press “YES/up” arrow button and the LED screen will display: “Setpoint = 40F” (Setpoint = 40F is the default setting). Temperature cannot be set lower than 0°F.
3. Press the “YES/up” arrow button to raise the setpoint temperature. Press the “RETURN/down” arrow button to lower the setpoint temperature.
4. When the LED screen displays your setpoint temperature press the “ENTER/MENU” button and “Low Temp Alarm Setpoint= 35F” will display (Setpoint = 35F is the default setting).

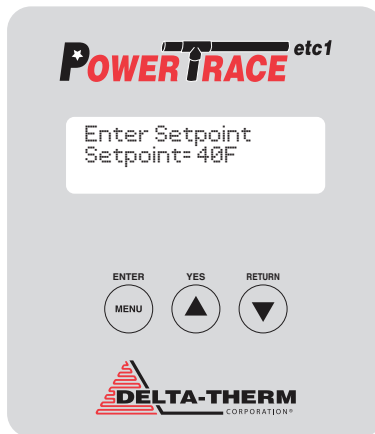

Detail 10. Press the “YES/up” arrow button to raise setpoint temperature. Press the “RETURN/down” arrow button to lower setpoint temperature. Press ENTER/MENU button to move on to next parameter.

Section 3. Programming

3.2 PROGRAMMING SETPOINT TEMPERATURE, LOW TEMPERATURE ALARM, HIGH TEMPERATURE ALARM, AND LOW CURRENT ALARM

2. **To enter or change the low temperature alarm:** After the “Low Temp Alarm Setpoint= 35F” is displayed you can change settings. Press “YES/up” arrow button to raise the low temperature alarm setpoint. Press the “RETURN/down” arrow button to lower the low temperature alarm setpoint.
3. When the LED screen displays your low temperature alarm setpoint press the “ENTER/MENU” button and “High Temp Alarm Setpoint= 250F” will display (Setpoint = 250F is the default setting).

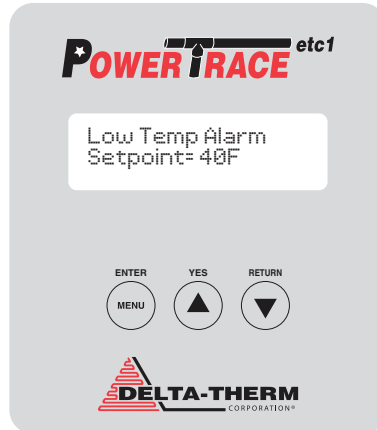

Detail 11. Press the “YES/up” arrow button to raise the Low Temp Alarm Setpoint. Press the “RETURN/down” arrow button to lower the Low Temp Alarm Setpoint. Press ENTER/MENU button to move on to next parameter.

4. **To enter or change the high temperature alarm:** After the “High Temp Alarm Setpoint= 250F” is displayed you can change settings. Press “YES/up” arrow button to raise the high temperature alarm setpoint. Press the “RETURN/down” arrow button to lower the high temperature alarm setpoint.
5. When the LED screen displays your high temperature alarm setpoint press the “ENTER/MENU” button and “Lo Current Alarm Select= 1 Amps” will display (Select= 1Amps is the default setting).

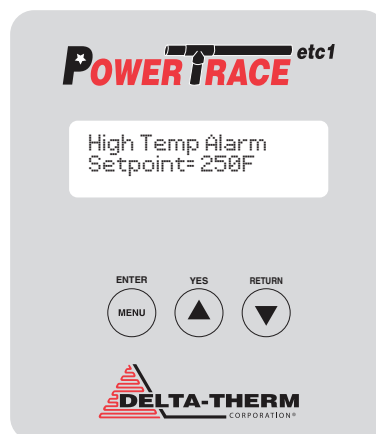

Detail 12. Press the “YES/up” arrow button to raise the High Temp Alarm Setpoint. Press the “RETURN/down” arrow button to lower The High Temp Alarm Setpoint. Press ENTER/MENU button to move on to next parameter.

Section 3. Programming

3.2 PROGRAMMING SETPOINT TEMPERATURE, LOW TEMPERATURE ALARM, HIGH TEMPERATURE ALARM, AND LOW CURRENT ALARM

1. **To enter or change the low current alarm:** After the “Lo Current Alarm Select= 1 AMPS” is displayed you can change settings. Press “YES/up” arrow button to raise the amp alarm. Press “RETURN/down” arrow button to lower the amp alarm.
2. When the LED screen displays your low current alarm press the “ENTER/MENU” button. The “Set Parameters? Yes or Return” message will reappear. Press the “RETURN/down” arrow button to return to the main display.

NOTE: selecting 0 (zero) current removes current monitoring from the device. The LED screen will display “Current mon. off”.

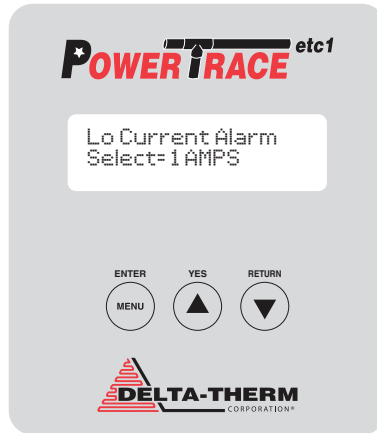

Detail 13. Press the “YES/up” arrow button to raise the Amp Alarm Setpoint. Press the “RETURN/down” arrow button to lower the Amp Alarm Setpoint.

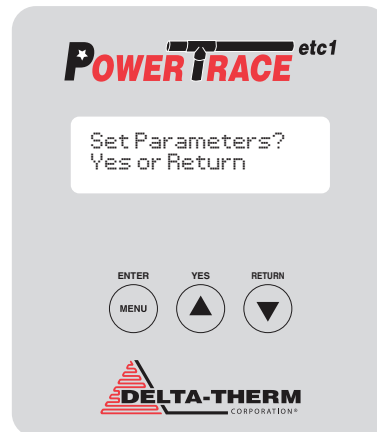

Detail 14. To return to main display press the “RETURN/down” arrow button.

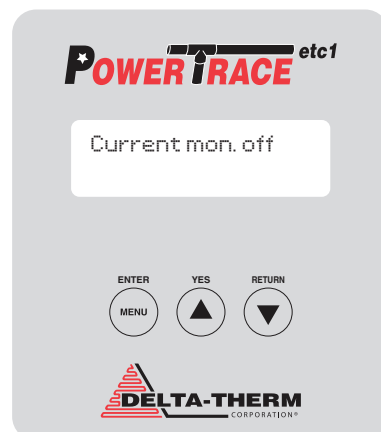

Detail 15. When current monitoring is disabled this message will be displayed.

Section 3. Programming

3.3 GROUND FAULT ALARM

NOTE: Only qualified personnel to open the PowerTrace enclosure. Line voltage is present on the circuit board.

The ground fault detection function deactivates the control panel and is a latching alarm. To check ground fault function open the enclosure door and press the test button on the circuit board to simulate a ground fault condition. The LED display indicates a ground fault condition and the alarm contacts close.

To reset the alarm open the enclosure door and press the reset button on the circuit board

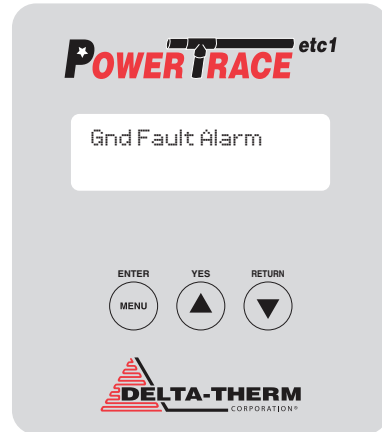

Detail 16. Will return to main display when ground fault is reset.

3.4 LED SCREEN ALARM DISPLAYS AND RESETTING ALARMS

LOW TEMPERATURE ALARM

Low temperature conditions will cause the alarm contacts to cycle on and off, causing the LED screen display to blink. The LED screen will display the temperature as detected by the RTD and the control panel setpoint temperature immediately followed by "System On," "Low Temp. Alarm."

HIGH TEMPERATURE ALARM

High temperature conditions will cause the alarm contacts to cycle on and off, causing the LED screen display to blink. The LED screen will display the temperature as detected by the RTD and the control panel setpoint temperature immediately followed by "System On," "High Temp. Alarm."

LOW CURRENT ALARM

Low current conditions will cause the alarm contacts to cycle on and off, causing the LED screen display to blink. The LED screen will display the temperature as detected by the RTD and the control panel setpoint temperature immediately followed by "System On," "Lo Current Amps," and "Current 0 Amps."

GROUND FAULT ALARM

This is a latching alarm. 30 mA ground fault conditions will close the alarm contacts for remote indication. The LED screen will display "Gnd Fault Alarm." To reset the alarm open the enclosure door and press the reset button on the circuit board.

3.5 LOCKING THE KEYPAD

A red dipswitch, labeled enabled/disabled input, is located on the inside of the enclosure door. Move the dipswitch into the left position to enable the keypad. Move the dipswitch into the right position to disable the keypad.

Section 4. Trouble-Shooting And Technical Support

4.1 MAINTENANCE

Test the ground fault function monthly. Open the enclosure door and press the test button on the circuit board to simulate a ground fault condition. The LED display indicates a ground fault condition and the alarm contacts close. To reset the alarm open the enclosure door and press the reset button on the circuit board.

4.2 SYSTEM FUNCTION TEST

1. Ensure all wiring is complete, cable has been tested per manufacturer's instructions, and piping system can accept heat.
2. Apply power to the PowerTrace etc1 control panel.
3. Verify parameters and readings.
4. Activate by setting setpoint above the temperature at the RTD, verify readings.
5. Return setpoint to required value.

4.3 TROUBLE-SHOOTING AND TECHNICAL SUPPORT

1. Verify that the heat trace cable and PowerTrace etc1 are the same voltage.
2. 0°F or 1023°F temperature is displayed: check RTD & RTD wiring.
3. Low current alarm: for self-regulating or self-limiting cable set the current value two amps less than the lowest current to be drawn during activation, for constant wattage type cable set the current alarm two amps less than actual draw to avoid false alarms due to voltage fluctuations. Amperage less than 0.5 amps will cause alarm. Turn current monitoring off for this condition.
4. Ground fault alarm: press reset button. If reset button doesn't reset the PowerTrace then disconnect load wiring and investigate cable load for damage, improper power connections, splices, terminations, etc.
5. High temp alarm: Verify high temp alarm setting is greater than temperatures seen by pipe system.
6. Low temp alarm: Verify low temp alarm setting, check pipe insulation for damage, moisture, etc. Verify wattage.
7. If banner flashes "Delta-Therm" repeatedly the control requires service, please call Delta-Therm technical support at (800) 526-7887.

If you have any questions or comments about these instructions, or your installation please call Delta-Therm between the hours of 7:00 a.m. - 5:30 p.m. CST, Monday through Friday at 1-800-526-7887.